

| | | |
|--------|-------------------------------|--|
| Group: | 8SC/SCJ | Notes: Refer to SP1017-DWG for major component drawing. Refer to TSB-3018 for hardware kit breakdown. Refer to TSB-3008 for Intake Nozzle kit breakdown. Refer to TSB-1104 for Trash Screen Assy. kit breakdown. Refer to TSB-1105 for Overhaul kit bearing change procedure. |
| Form: | SP1017 | |
| Date: | January 29, 2010 | |
| File: | Alternator Parts List Section | |

Identify the part number of the unit you have. In addition to identifying the part number from the part label it is also required that you identify the REV level. It is probable that no REV level is present; if so, utilize the part number only to identify the appropriate part. However, if a REV level is present, choose the applicable part for that REV level which is listed below the part number.

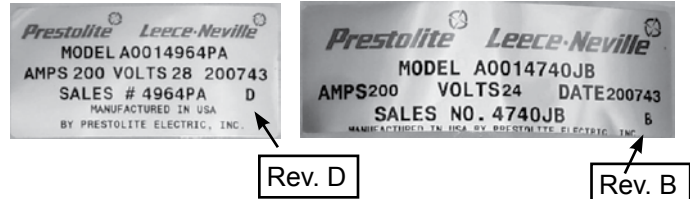

“Rev.” This indicates the revision letter on the label. If your unit is this revision or later, use this service component.







| Component View | Front Housing w/o Bearing | Rotor | Rear Housing w/o Bearing | Rectifier Assy. | Stator | Regulator |
|----------------|---------------------------|-------------|--------------------------|-----------------|-------------|-------------|
| | | | | | | |
| Model | 1 | 2 | 3 | 4 | 5 | 6 |
| 8SC2020Z | 1544372C01S | 5944676C08S | 1544373C06S | A051104248S | 0142000T32S | 8RL2134S |
| REV: F | A015102959S | A020104240S | A012102963S | A051104248S | 0142000T32S | 8RL2135S |
| 8SC2020Z-JD | 1544372C01S | 5944676C10S | 1544373C06S | A051104248S | 0142000T32S | 8RL2134S |
| REV: H | A015102959S | A020104240S | A012102963S | A051104248S | 0142000T32S | 8RL2135S |
| 8SC2023Z | 1544372C01S | 5944676C08S | 1544373C06S | A051104248S | 0142000T32S | 8RL2126S |
| REV: F | A015102959S | A020104240S | A012102963S | A051104248S | 0142000T32S | 8RL2133S |
| 8SC2023Z-NHK | 1544372C01S | 5944676C10S | 1544373C10S | A051104248S | 0142000T32S | 8RL2126S |
| 8SC2023Z-NHS | 1544372C01S | 5944676C10S | 1544373C10S | A051104248S | 0142000T32S | 8RL2126S |
| 8SC2202V-CA | 1544372C01S | 5944676C10S | 1544373C12S | A051104248S | 0142000T32S | 8RL2127S |
| 8SC2205V-CA | 1544372C01S | 5944676C10S | 1544373C10S | A051104248S | 0142000T32S | 8RL2127S |
| 8SC2223V | 1544372C01S | 5944676C10S | 1544373C10S | A051104248S | 0142000T32S | 8RL2127S |
| 8SC2223VG | 1544372C01S | 5944676C10S | 1544373C10S | A051104248S | 0142000T32S | 8RL2127S |
| 8SC2223V-K | 1544372C01S | 5944676C10S | 1544373C10S | A051104248S | 0142000T32S | 8RL2127S |
| 8SC2236 | A015102959S | A020104240S | A012104338S | A051104248S | 0142000T32S | 8RL2131S |
| 8SC2282V | A015102959S | A020104240S | A012102963S | A051104248S | 0142000T32S | 8RL2131S |
| 8SC2282VG | A015102959S | A020104240S | A012102963S | A051104248S | 0142000T32S | 8RL2131S |
| 8SC2285V | A015102959S | A020104240S | A012102963S | A051104248S | 0142000T32S | 8RL2131S |
| 8SC3009ZA | 1544372C01S | 0142499T73S | 1544373C06S | A051104922S | 0142000T32S | 8RL3024S * |
| REV: BE | A015102959S | A020104392S | A012102963S | A051104922S | A022104726S | 8RL3028S ** |
| 8SC3009ZAC | A015102959S | A020104392S | A012102963S | A051104922S | A022107726S | 8RL3028S ** |
| 8SC3014U | 1544372C05S | 0142499T73S | 1544373C08S | A051104748S | 0142499T77S | 8RL3024S * |
| REV: AH | A015104754S | A020105223S | A012102963S | A051104748S | A022104753S | 8RL3028S ** |

* For adjustable version use 8RL3109S

** For adjustable version use 8RL3136S

Important: The information contained in this bulletin is intended for use by trained, professional technicians who have the proper tools, equipment, and training to perform the required maintenance described above. This information is NOT intended for ‘do-it-yourselfers’, and you should not assume that this information applies to your equipment. If you have any questions regarding this information please visit our website at www.prestolite.com, or contact our technical service department at:

| | | |
|--------|-------------------------------|--|
| Group: | 8SC/SCJ | Notes: Refer to SP1017-DWG for major component drawing. Refer to TSB-3018 for hardware kit breakdown. Refer to TSB-3008 for Intake Nozzle kit breakdown. Refer to TSB-1104 for Trash Screen Assy. kit breakdown. Refer to TSB-1105 for Overhaul kit bearing change procedure. |
| Form: | SP1017 | |
| Date: | January 29, 2010 | |
| File: | Alternator Parts List Section | |







| Component View | Front Housing w/o Bearing | Rotor | Rear Housing w/o Bearing | Rectifier Assy. | Stator | Regulator |
|----------------|---|---|---|---|--|---|
| |  |  |  |  |  |  |
| Model | 1 | 2 | 3 | 4 | 5 | 6 |
| 8SC3015U | 1544372C01S | 0142499T87S | 1544373C06S | A051104922S | 0142499T90S | 8RL3024S * |
| REV: AG | A015102959S | A020105116S | A012102963S | A051104922S | A022104717S | 8RL3028S ** |
| 8SC3019U | 1544372C01S | 0142499T87S | 1544373C06S | A051104922S | 0142499T90S | 8RL3024S * |
| REV: AG | A015102959S | A020105116S | A012102963S | A051104922S | A020104395S | 8RL3028S ** |
| 8SC3029Z | 1544372C01S | 0142499T73S | 1544373C06S | A051104922S | 0142000T32S | 8RL3024S * |
| REV: E | A015102959S | A020104392S | A012102963S | A051104922S | A022104726S | 8RL3028S ** |
| 8SC3068V | 1544372C01S | 0142000T04S | 1544373C06S | A051104922S | A022102287S | 8RL3024S * |
| REV:BD | A015102959S | A020104395S | A012102963S | A051104922S | A022104709S | 8RL3028S ** |
| 8SC3068VC | A015102959S | A020104395S | A012102963S | A051104922S | A022104709S | 8RL3028S |
| 8SC3110V | 1544372C01S | 5944676C09S | 1544373C06S | A051104363S | 0180000N80S | 8RL3023CS |
| REV: G | A015102959S | A020104358S | A012102963S | A051104363S | A022104383S | 8RL3140S |
| 8SC3133U | A015102959S | A020105223S | A012102963S | A051104748S | A022104753S | 8RL3136S |
| 8SC3157V | A015102959S | A020104392S | A012102963S | A051104922S | A022104726S | 8RL3136S |
| 8SC3160V | A015102959S | A020104395S | A012102963S | A051104922S | A022104709S | 8RL3136S |
| 8SC3169U | A015102959S | A020104395S | A012102963S | A051104922S | A022104717S | 8RL3136S |
| 8SC3200V | A015102959S | A020104358S | A012103963S | A051105445S | A022104383S | 8RL3145S |
| 8SC3207V | A015102959S | A020104395S | A012102963S | A051105445S | A022104709S | 8RL3145S |
| 8SC3248V | A015102959S | A020105223S | A012102963S | A051104363S | A022104753S | 8RL3140S |
| SCJ2165 | A015102959S | A020103043S | A012102963S | A051104248S | 0142000T32S | 8RL2126S |
| SCJ2167 | A015102959S | 5944676C10S | A012102963S | A051104248S | 0142000T32S | 8RL2126S |
| SCJ2216 | A015102959S | A020103043S | A012102963S | A051104248S | 0142000T32S | 8RL2126S |
| SCJ2217 | A015102959S | 5944676C10S | A012102963S | A051104248S | 0142000T32S | 8RL2126S |
| SCJ2219 | A015102959S | A020103043S | A012102963S | A051104288S | 0142000T32S | 8RL2130S |
| SCJ2221 | A015102959S | A020103043S | A012102963S | A051104288S | 0142000T32S | 8RL2130S |
| SCJ2225 | A015102959S | A020104296S | A012102963S | A051104248S | 0142000T32S | 8RL2133S |
| SCJ2226 | A015102959S | A020104296S | A012102963S | A051104248S | 0142000T32S | 8RL2133S |
| SCJ2227 | A015102959S | A020104240S | A012102963S | A051104248S | 0142000T32S | 8RL2133S |
| SCJ2231 | A015102959S | A020104296S | A012102963S | A051104288S | 0142000T32S | 8RL2132S |
| SCJ2232 | A015102959S | A020104240S | A012102963S | A051104288S | 0142000T32S | 8RL2132S |
| SCJ2233 | A015102959S | A020104240S | A012102963S | A051104288S | 0142000T32S | 8RL2132S |
| SCJ2239 | A015102959S | A020104296S | A012102963S | A051104288S | 0142000T32S | 8RL2132S |
| SCJ2287 | A015102959S | A020104240S | A012102963S | A051104248S | 0142000T32S | 8RL2133S |
| SCJ3126 | A015102959S | 0142000T04S | A012102963S | A051104391S | A022102815S | 8RL3107S |
| SCJ3128 | A015102958S | 5944676C25S | A012102962S | A051104363S | 0142499T90S | 8RL3107S |
| SCJ3147 | A015102959S | A020104395S | A012102963S | A051104363S | A022104709S | 8RL3028S |

* For adjustable version use 8RL3109S

** For adjustable version use 8RL3136S





Important: The information contained in this bulletin is intended for use by trained, professional technicians who have the proper tools, equipment, and training to perform the required maintenance described above. This information is NOT intended for 'do-it-yourselfers', and you should not assume that this information applies to your equipment. If you have any questions regarding this information please visit our website at www.prestolite.com, or contact our technical service department at:

| | | |
|--------|-------------------------------|--|
| Group: | 8SC/SCJ | Notes: Refer to SP1017-DWG for major component drawing. Refer to TSB-3018 for hardware kit breakdown. Refer to TSB-3008 for Intake Nozzle kit breakdown. Refer to TSB-1104 for Trash Screen Assy. kit breakdown. Refer to TSB-1105 for Overhaul kit bearing change procedure. |
| Form: | SP1017 | |
| Date: | January 29, 2010 | |
| File: | Alternator Parts List Section | |

| Component View | Front Housing w/o Bearing | Rotor | Rear Housing w/o Bearing | Rectifier Assy. | Stator | Regulator |
|----------------|---|---|---|--|---|---|
| |  |  |  |  |  |  |
| Model | 1 | 2 | 3 | 4 | 5 | 6 |
| SCJ3162 | A015102959S | A020104395S | A012102963S | A051104391S | A022104709S | 8RL3141S |
| SCJ3218 | A015102958S | A020104716S | A012103185S | A051104363S | A022102815S | 8RL3027 |
| REV: E | A015103185S | A020104716S | A012102958S | A051104363S | A022102815S | 8RL3141S |
| SCJ3291 | A015102959S | A020104395S | A012102963S | A051104391S | A022104709S | 8RL3141S |
| SCJ3292 | A015102959S | A020104395S | A012102963S | A051104391S | A022104709S | 8RL3141S |





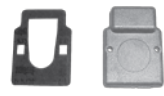

Important: The information contained in this bulletin is intended for use by trained, professional technicians who have the proper tools, equipment, and training to perform the required maintenance described above. This information is NOT intended for 'do-it-yourselfers', and you should not assume that this information applies to your equipment. If you have any questions regarding this information please visit our website at www.prestolite.com, or contact our technical service department at:

| | | |
|--------|-------------------------------|--|
| Group: | 8SC/SCJ | Notes: Refer to SP1017-DWG for major component drawing. Refer to TSB-3018 for hardware kit breakdown. Refer to TSB-3008 for Intake Nozzle kit breakdown. Refer to TSB-1104 for Trash Screen Assy. kit breakdown. Refer to TSB-1105 for Overhaul kit bearing change procedure. |
| Form: | SP1017 | |
| Date: | January 29, 2010 | |
| File: | Alternator Parts List Section | |

| Component View | Fan | Hardware Kit | Overhaul Kit Bearings, slip ring, O-ring, brush holder | Terminal Board / Plug Kit | Brush Kit | Rear Cover & Gasket |
|----------------|---|---|---|--|---|---|
| |  |  |  |  Or |  |  |
| Model | 7 | 8 | 9 | 10 | 11 | 12 |
| 8SC2020Z | A041102954S | K212103996S | K183103997S | K185103975S | K185103972S | K185103973S |
| REV: F | A041104228S | K212103996S | K183103997S | K185103976S | K185103972S | K185103973S |
| 8SC2020Z-JD | A041102954S | K212103996S | K183103997S | K185103975S | K185103972S | K185103973S |
| REV: H | A041104228S | K212103996S | K183103997S | K185103976S | K185103972S | K185103973S |
| 8SC2023Z | A041102954S | K212103996S | K183103997S | K185103975S | K185103972S | K185103973S |
| REV: F | A041104228S | K212103996S | K183103997S | K185103976S | K185103972S | K185103973S |
| 8SC2023-NHK | A041102954S | K212103996S | K183103997S | K185103975S | K185103972S | K185103973S |
| 8SC2023Z-NHS | A041102954S | K212103996S | K183103997S | K185103975S | K185103972S | K185103973S |
| 8SC2202V-CA | A041102954S | K212103996S | K183103997S | K185103975S | K185103972S | K185103973S |
| 8SC2205-CA | A041102954S | K212103996S | K183103997S | K185103975S | K185103972S | K185103973S |
| 8SC2223V | A041102954S | K212103996S | K183103997S | K185103975S | K185103972S | K185103973S |
| 8SC2223VG | A041102954S | K212103996S | K183103997S | K185103975S | K185103972S | K185103973S |
| 8SC2223V-K | A041102954S | K212103996S | K183103997S | K185103975S | K185103972S | K185103973S |
| 8SC2236 | A041104228S | K212103996S | K183103997S | K185103976S | K185103972S | K185103973S |
| 8SC2282V | A041104228S | K212103996S | K183103997S | K185103976S | K185103972S | K185103973S |
| 8SC2282VG | A041104228S | K212103996S | K183103997S | K185103976S | K185103972S | K185103973S |
| 8SC2285V | A041104228S | K212103996S | K183103997S | K185103976S | K185103972S | K185103973S |
| 8SC3009ZA | A041102954S | K212103996S | K183103997S | K185103975S | K185103972S | K185103973S |
| REV: BE | A041104228S | K212103996S | K183103997S | K185103976S | K185103972S | K185103973S |
| 8SC3009ZAC | A041104228S | K212103996S | K183103997S | K185103976S | K185103972S | K185103973S |
| 8SC3014U | A041102954S | K212103996S | K183103997S | K185103975S | K185103972S | K185103973S |
| REV: AH | A041104228S | K212103996S | K183103997S | K185103976S | K185103972S | K185103973S |
| 8SC3015U | A041102954S | K212103996S | K183103997S | K185103975S | K185103972S | K185103973S |
| REV: AG | A041104228S | K212103996S | K183103997S | K185103976S | K185103972S | K185103973S |
| 8SC3019U | A041102954S | K212103996S | K183103997S | K185103975S | K185103972S | K185103973S |
| REV: AG | A041104228S | K212103996S | K183103997S | K185103976S | K185103972S | K185103973S |
| 8SC3029Z | A041102954S | K212103996S | K183103997S | K185103975S | K185103972S | K185103973S |
| REV: E | A041104228S | K212103996S | K183103997S | K185103976S | K185103972S | K185103973S |
| 8SC3068V | A041102954S | K212103996S | K183103997S | K185103975S | K185103972S | K185103973S |
| REV: BD | A041104228S | K212103996S | K183103997S | K185103976S | K185103972S | K185103973S |
| 8SC3068VC | A041104228S | K212103996S | K183103997S | K185103976S | K185103972S | K185103973S |
| 8SC3110V | A041102954S | K212103996S | K183103997S | K185103975S | K185103972S | K185103973S |
| REV: G | A041104228S | K212103996S | K183103997S | K185103976S | K185103972S | K185103973S |



Important: The information contained in this bulletin is intended for use by trained, professional technicians who have the proper tools, equipment, and training to perform the required maintenance described above. This information is NOT intended for 'do-it-yourselfers', and you should not assume that this information applies to your equipment. If you have any questions regarding this information please visit our website at www.prestolite.com, or contact our technical service department at:

| | | |
|--------|-------------------------------|--|
| Group: | 8SC/SCJ | Notes: Refer to SP1017-DWG for major component drawing. Refer to TSB-3018 for hardware kit breakdown. Refer to TSB-3008 for Intake Nozzle kit breakdown. Refer to TSB-1104 for Trash Screen Assy. kit breakdown. Refer to TSB-1105 for Overhaul kit bearing change procedure. |
| Form: | SP1017 | |
| Date: | January 29, 2010 | |
| File: | Alternator Parts List Section | |

| Component View | Fan | Hardware Kit | Overhaul Kit Bearings, slip ring, O-ring, brush holder | Terminal Board / Plug Kit | Brush Kit | Rear Cover & Gasket |
|---|---|---|--|---|---|---------------------|
|  |  |  |  |  |  | |
| Model | 7 | 8 | 9 | 10 | 11 | 12 |
| 8SC3133U | A041104228S | K212103996S | K183103997S | K185103975S | K185103972S | K185103973S |
| 8SC3157V | A041104228S | K212103996S | K183103997S | K185103976S | K185103972S | K185103973S |
| 8SC3160V | A041104228S | K212103996S | K183103997S | K185103976S | K185103972S | K185103973S |
| 8SC3169U | A041104228S | K212103996S | K183103997S | K185103976S | K185103972S | K185103973S |
| 8SC3200V | A041104228S | K212103996S | K183103997S | K185103976S | K185103972S | K185103973S |
| 8SC3207V | A041104228S | K212103996S | K183103997S | K185103976S | K185103972S | K185103973S |
| 8SC3248V | A041104228S | K212103996S | K183103997S | K185103976S | K185103972S | K185103973S |
| SCJ2165 | A041102954S | K212103996S | K183103997S | K185103975S | K185103972S | K185103973S |
| SCJ2167 | A041102954S | K212103996S | K183103997S | K185103975S | K185103972S | K185103973S |
| SCJ2216 | A041102954S | K212103996S | K183103997S | K185103975S | K185103972S | K185103973S |
| SCJ2217 | A041102954S | K212103996S | K183103997S | K185103975S | K185103972S | K185103973S |
| SCJ2219 | A041102954S | K212103996S | K183103997S | K185103975S | K185103972S | K185103973S |
| SCJ2221 | A041102954S | K212103996S | K183103997S | K185103975S | K185103972S | K185103973S |
| SCJ2225 | A041102954S | K212103996S | K183103997S | K185103976S | K185103972S | K185103973S |
| SCJ2226 | A041102954S | K212103996S | K183103997S | K185103976S | K185103972S | K185103973S |
| SCJ2227 | A041102954S | K212103996S | K183103997S | K185103976S | K185103972S | K185103973S |
| SCJ2231 | A041102954S | K212103996S | K183103997S | K185103976S | K185103972S | K185103973S |
| SCJ2232 | A041102954S | K212103996S | K183103997S | K185103976S | K185103972S | K185103973S |
| SCJ2233 | A041102954S | K212103996S | K183103997S | K185103976S | K185103972S | K185103973S |
| SCJ2239 | A041102954S | K212103996S | K183103997S | K185103976S | K185103972S | K185103973S |
| SCJ2287 | A041102954S | K212103996S | K183103997S | K185103976S | K185103972S | K185103973S |
| SCJ3126 | A041102954S | K212103996S | K183103997S | K185103975S | K185103972S | K185103973S |
| SCJ3128 | A041102955S | K212103996S | K183103997S | K185103975S | K185103972S | K185103973S |
| SCJ3147 | A041102955S | K212103996S | K183103997S | K185103976S | K185103972S | K185103973S |
| SCJ3162 | A041102954S | K212103996S | K183103997S | K185103976S | K185103972S | K185103973S |
| SCJ3218 | A041102954S | K212103996S | K183103997S | K185103975S | K185103972S | K185103973S |
| REV: E | A041102955S | K212103996S | K183103997S | K185103976S | K185103972S | K185103973S |
| SCJ3291 | A041102954S | K212103996S | K183103997S | K185103976S | K185103972S | K185103973S |
| SCJ3292 | A041102954S | K212103996S | K183103997S | K185103976S | K185103972S | K185103973S |



Important: The information contained in this bulletin is intended for use by trained, professional technicians who have the proper tools, equipment, and training to perform the required maintenance described above. This information is NOT intended for 'do-it-yourselfers', and you should not assume that this information applies to your equipment. If you have any questions regarding this information please visit our website at www.prestolite.com, or contact our technical service department at:

| | | |
|--------|-------------------------------|--|
| Group: | 8SC/SCJ | Notes: Refer to SP1017-DWG for major component drawing. Refer to TSB-3018 for hardware kit breakdown. Refer to TSB-3008 for Intake Nozzle kit breakdown. Refer to TSB-1104 for Trash Screen Assy. kit breakdown. Refer to TSB-1105 for Overhaul kit bearing change procedure. |
| Form: | SP1017 | |
| Date: | January 29, 2010 | |
| File: | Alternator Parts List Section | |

| Component View | Trash Screen Assy. Kit | Diode Trio Assy. | Capacitor Assy. |
|----------------|---|---|--|
| |  |  |  Or |
| Model | 13 | | |
| 8SC2020Z | N/A | N/A | N/A |
| REV: F | N/A | N/A | N/A |
| 8SC2020Z-JD | N/A | N/A | N/A |
| REV: H | N/A | N/A | N/A |
| 8SC2023Z | N/A | N/A | N/A |
| REV: F | N/A | N/A | N/A |
| 8SC2023-NHK | K185103971S | N/A | N/A |
| 8SC2023Z-NHS | K185103971S | N/A | N/A |
| 8SC2202V-CA | N/A | N/A | N/A |
| 8SC2205-CA | N/A | N/A | N/A |
| 8SC2223V | K185103971S | N/A | N/A |
| 8SC2223VG | K185103971S | N/A | N/A |
| 8SC2223V-K | K185103971S | N/A | N/A |
| 8SC2236 | N/A | N/A | N/A |
| 8SC2282V | K185103971S | N/A | N/A |
| 8SC2282VG | K185103971S | N/A | N/A |
| 8SC2285V | N/A | N/A | N/A |
| 8SC3009ZA | N/A | 0144445S03S | 0844474C01S |
| REV: BE | N/A | N/A | N/A |
| 8SC3009ZAC | N/A | N/A | NA |
| 8SC3014U | N/A | 0144445S05S | 0844474C01S |
| REV:AH | N/A | N/A | N/A |
| 8SC3015U | N/A | 0144445S03S | K185103977S |
| REV: AG | N/A | N/A | K185103977S |
| 8SC3019U | N/A | 0144445S03S | 0844474C01S |
| REV: AG | N/A | N/A | N/A |
| 8SC3029Z | N/A | 0144445S03S | 0844474C01S |
| REV: E | N/A | N/A | N/A |
| 8SC3068V | N/A | 0144445S03S | 0844474C01S |
| REV: BD | N/A | N/A | N/A |
| 8SC3110V | N/A | N/A | 0844474C01S |
| REV: G | N/A | N/A | N/A |
| 8SC3133U | N/A | N/A | N/A |
| 8SC3157V | N/A | N/A | N/A |
| 8SC3160V | N/A | N/A | N/A |
| 8SC3169U | N/A | N/A | K185103977S |
| 8SC3200V | N/A | N/A | N/A |

Important: The information contained in this bulletin is intended for use by trained, professional technicians who have the proper tools, equipment, and training to perform the required maintenance described above. This information is NOT intended for 'do-it-yourselfers', and you should not assume that this information applies to your equipment. If you have any questions regarding this information please visit our website at www.prestolite.com, or contact our technical service department at:

| | | |
|--------|-------------------------------|--|
| Group: | 8SC/SCJ | Notes: Refer to SP1017-DWG for major component drawing. Refer to TSB-3018 for hardware kit breakdown. Refer to TSB-3008 for Intake Nozzle kit breakdown. Refer to TSB-1104 for Trash Screen Assy. kit breakdown. Refer to TSB-1105 for Overhaul kit bearing change procedure. |
| Form: | SP1017 | |
| Date: | January 29, 2010 | |
| File: | Alternator Parts List Section | |

| Component View | Trash Screen Assy. Kit | Diode Trio Assy. | Capacitor Assy. |
|----------------|---|---|--|
| |  |  |  Or |
| Model | 13 | | |
| 8SC3207V | N/A | N/A | N/A |
| 8SC3248V | N/A | N/A | N/A |
| SCJ2165 | K185103971S | N/A | N/A |
| SCJ2167 | K185103971S | N/A | N/A |
| SCJ2216 | K185103971S | N/A | N/A |
| SCJ2217 | K185103971S | N/A | N/A |
| SCJ2219 | K185103971S | 0144445S03S | N/A |
| SCJ2221 | K185103971S | 0144445S03S | N/A |
| SCJ2225 | K185103971S | N/A | N/A |
| SCJ2226 | K185103971S | N/A | N/A |
| SCJ2227 | K185103971S | N/A | N/A |
| SCJ2231 | K185103971S | N/A | N/A |
| SCJ2232 | K185103971S | N/A | N/A |
| SCJ2233 | K185103971S | N/A | N/A |
| SCJ2239 | K185103971S | N/A | N/A |
| SCJ2287 | K185103971S | N/A | N/A |
| SCJ3126 | K185103971S | N/A | 0844474C01S |
| SCJ3128 | K185103971S | N/A | 0844474C01S |
| SCJ3147 | K185103971S | N/A | N/A |
| SCJ3162 | K185103971S | N/A | N/A |
| SCJ3218 | N/A | N/A | 0844474C01S |
| REV: E | N/A | N/A | N/A |
| SCJ3291 | N/A | N/A | N/A |
| SCJ3292 | K185103971S | N/A | N/A |

| Component View | Intake Air Nozzle Kit |
|----------------|---|
| |  |
| Model | 14 |
| 8SC2202V-CA | A544104734S |
| 8SC2236 | A544104734S |
| SCJ3218 | A544104734S |

Important: The information contained in this bulletin is intended for use by trained, professional technicians who have the proper tools, equipment, and training to perform the required maintenance described above. This information is NOT intended for 'do-it-yourselfers', and you should not assume that this information applies to your equipment. If you have any questions regarding this information please visit our website at www.prestolite.com, or contact our technical service department at:

| | | |
|--------|-------------------------------|--|
| Group: | 8SC / SCJ | Notes: |
| Form: | SP1017-DWG | Refer to SP1017 8SC-SCJ for parts breakdown. Refer to TSB-3018 for hardware kit breakdown. Refer to TSB-3008 for Intake Nozzle kit breakdown. Refer to TSB-1104 for Trash Screen Assy. kit breakdown. Refer to TSB-1105 for Overhaul kit bearing change procedure. |
| Date: | July 10, 2008 | |
| File: | Alternator Parts List Section | |

8SC / SCJ Major Service Components

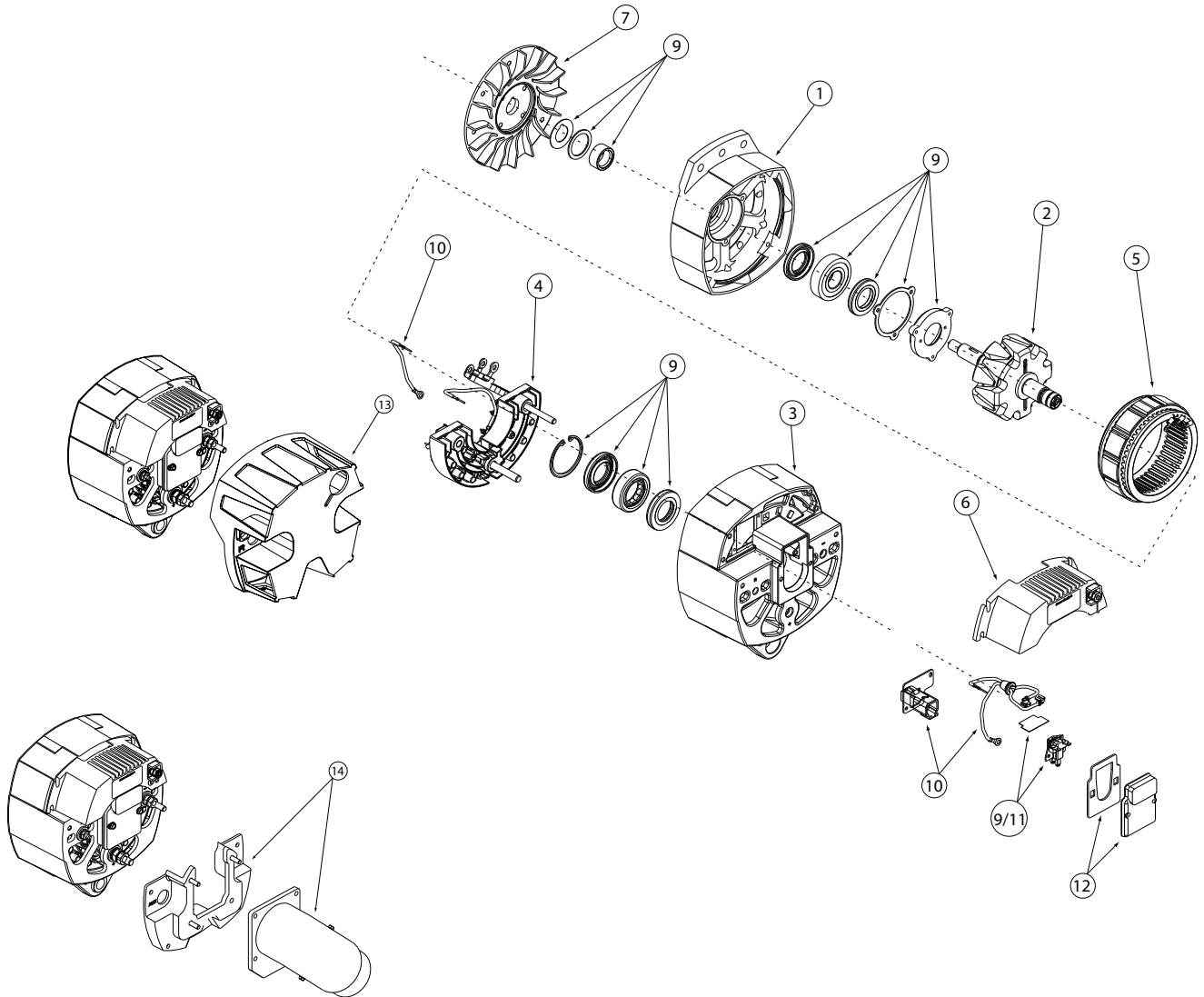

See TSB-3018
for Hardware Kit
breakdown

Important: The information contained in this bulletin is intended for use by trained, professional technicians who have the proper tools, equipment, and training to perform the required maintenance described above. This information is NOT intended for 'do-it-yourselfers', and you should not assume that this information applies to your equipment. If you have any questions regarding this information please visit our website at www.prestolite.com, or contact our technical service department at:

Source: Leece-Neville Heavy Duty Systems Division - Arcade, NY USA
Date: July 8, 2008
Bulletin No: TSB-3018
Models: 8SC/SCJ
Subject: Hardware Kit for 8SC/SCJ alternators K212103996S

K212103996S

NOTE: All of these components are part of the hardware kit and not available for individual purchase.

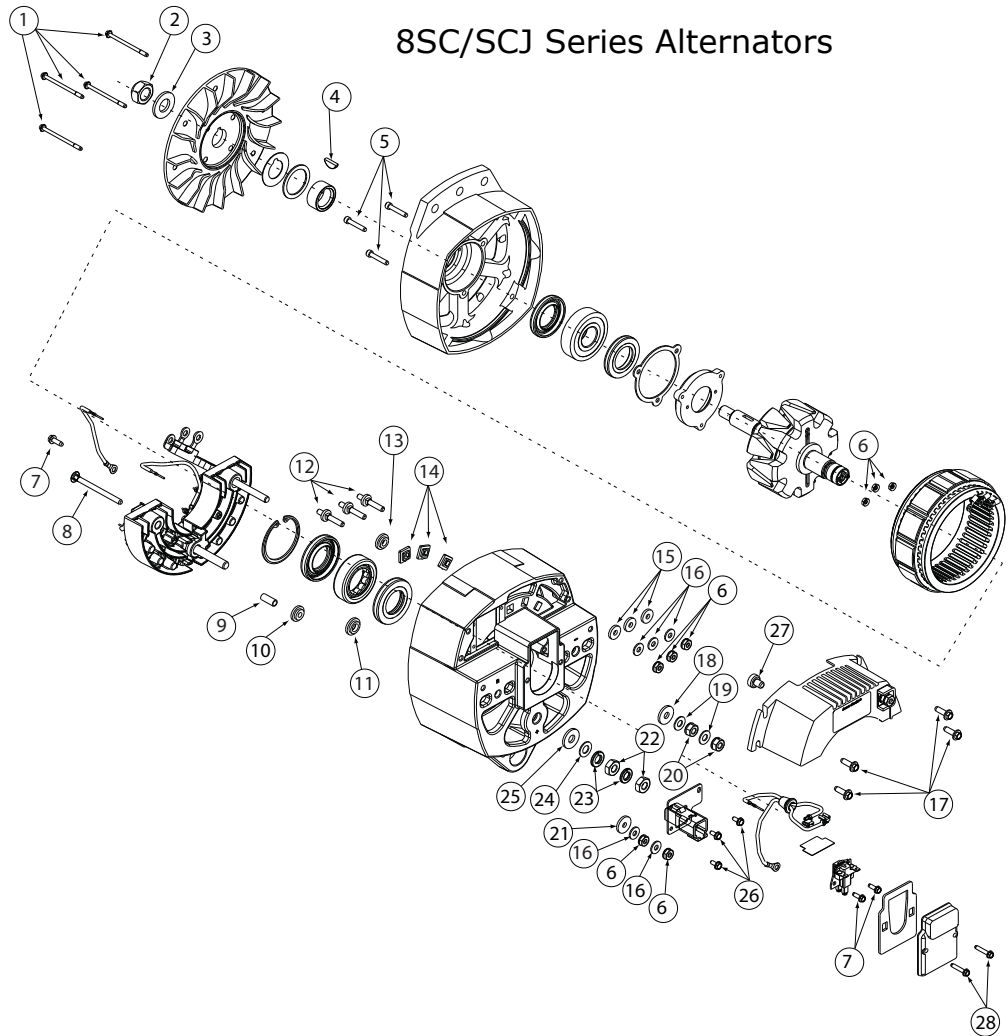

Important: The information contained in this bulletin is intended for use by trained, professional technicians who have the proper tools, equipment, and training to perform the required maintenance described above. This information is NOT intended for 'do-it-yourselfers', and you should not assume that this information applies to your equipment. If you have any questions regarding this information please visit our website at www.prestolite.com, or contact our technical service department at:

Date: July 8, 2008

Bulletin No: TSB-3018

8SC/SCJ series Hardware - K212103996S

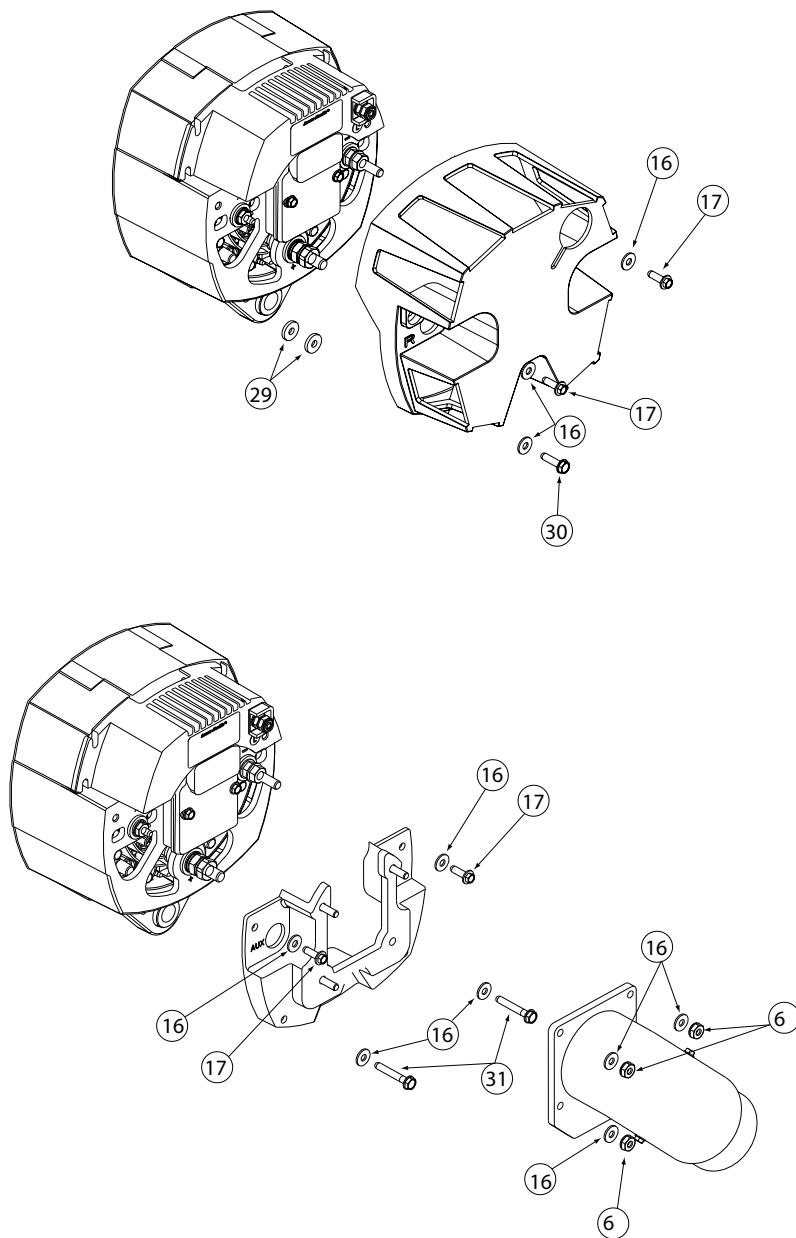

Important: The information contained in this bulletin is intended for use by trained, professional technicians who have the proper tools, equipment, and training to perform the required maintenance described above. This information is NOT intended for 'do-it-yourselfers', and you should not assume that this information applies to your equipment. If you have any questions regarding this information please visit our website at www.prestolite.com, or contact our technical service department at:

Date: July 8, 2008

Bulletin No: TSB-3018

| Description | Qty. | Key | Where used |
|--------------------------|------|-----|---|
| BOLT, THRU-10-32 2.86L | 4 | 1 | Holds alternator together |
| 5/8-18NF-2B PULLEY LCK | 1 | 2 | Pulley nut |
| WASHER FLAT | 1 | 3 | Pulley nut flat washer |
| KEY, WOODRUFF #8 | 1 | 4 | Pulley woodruff key |
| BRG RET SCREW | 3 | 5 | Front bearing retainer screws |
| NUT CON LOCK 10-24 3/8 | 8 | 6 | Stator/ output terminal nuts |
| SCR TPG 8-32X.50 1/4HD | 3 | 7 | Brush/ rectifier screws |
| RNC-BOLT M8-1.25 2.13L | 1 | 8 | D+ / AC bolt |
| INSULATOR SLEEVE | 1 | 9 | D+ / AC bolt insulator |
| WSHR INSL #10 BOLT | 1 | 10 | D+ / AC bolt insulator |
| WSHR INSL 5/16 BOLT | 1 | 11 | B+ bolt insulator |
| STUD, DOUBLE ENDED | 3 | 12 | AC bolts |
| WSHR INSL 1/4 BOLT | 1 | 13 | B- bolt insulator |
| INSULATOR | 3 | 14 | AC bolts insulator |
| WASHER, GPO-1 INSULATING | 3 | 15 | AC bolts insulator |
| WASHER FLT.203-.500-.0 | 11 | 16 | Output studs washers |
| SCR TPG 10-32X.62 1/4H | 6 | 17 | Attaching bolts for regulator, screen and intake nozzle |
| WSHR INSL .09THX.75 | 1 | 18 | B- bolt insulator |
| WSHR FLT .266-.562- | 2 | 19 | B- bolt flat washer |
| NUT CONL 1/4-28-3/16TK | 2 | 20 | B- bolt nuts |
| NUT, M6 | 2 | 20 | B- bolt nuts (Metric) |
| WSHR INSL .09THX.69 | 1 | 21 | D+ / AC bolt insulator |
| NUT 5/16-24X9/16X7/32 | 2 | 22 | B+ bolt nuts |
| NUT, M8 | 2 | 22 | B+ bolt nuts |
| WSHR LCK 5/16 MD SPT | 2 | 23 | B+ bolt lock washers |
| WSHR FLT .328-.625- | 1 | 24 | B+ bolt flat washer |
| WSHR INSL .09THX.81 | 1 | 25 | B+ bolt insulator |
| SCR TPG 6-32X11/32 PHW | 3 | 26 | Terminal board/ connecter screws |
| CAP, STUD | 1 | 27 | AC stud insulating cap |
| SCR TPG 8-32X.88 1/4HD | 2 | 28 | Brush cover screws |
| WSHR INSL #10.09THX9/1 | 2 | 29 | Screen spacer washers |
| SCREW, TAP, #10-32 X 3/4 | 1 | 30 | Screen attaching screw |
| Screw #10-32 X 1 1/4" | 2 | 31 | Intake nozzle attaching screws |

Important: The information contained in this bulletin is intended for use by trained, professional technicians who have the proper tools, equipment, and training to perform the required maintenance described above. This information is NOT intended for 'do-it-yourselfers', and you should not assume that this information applies to your equipment. If you have any questions regarding this information please visit our website at www.prestolite.com, or contact our technical service department at: